

COMP201

Computer Systems & Programming

Lecture #20 – Security Vulnerabilities

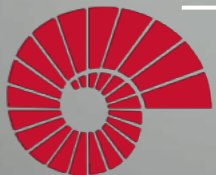

KOÇ
UNIVERSITY

Aykut Erdem // Koç University // Fall 2024

Recap

- Arrays
 - One-dimensional
 - Multi-dimensional (nested)
 - Multi-level
- Structures
 - Allocation
 - Access
 - Alignment

Recap: Array Allocation

Basic Principle

T $A[L];$

- Array of data type T and length L
- Contiguously allocated region of $L * \mathbf{sizeof}(T)$ bytes in memory

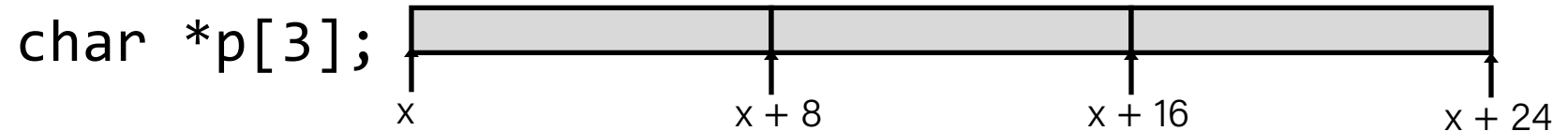
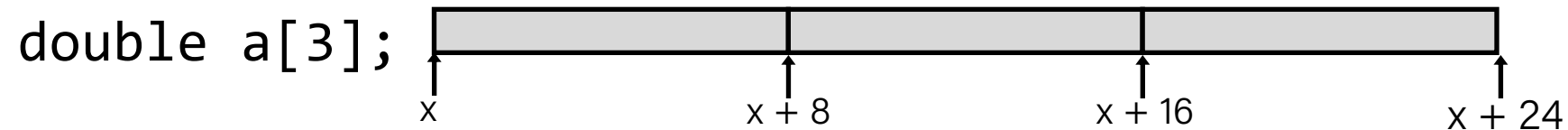
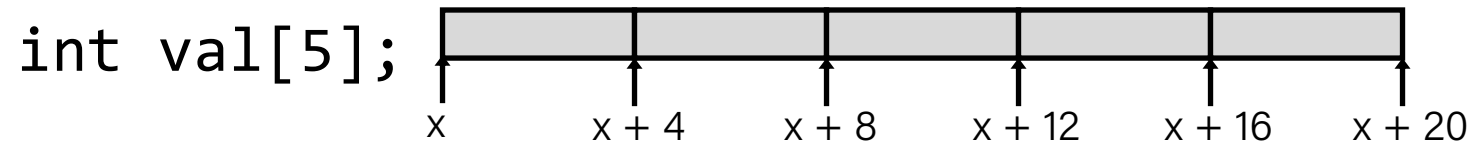
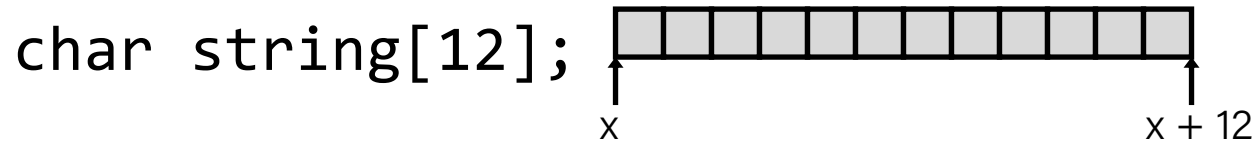

Recap: Multidimensional (Nested) Arrays

Declaration

```
T A[R][C];
```

- 2D array of data type T
- R rows, C columns
- Type T element requires K bytes

Array Size

- $R * C * K$ bytes

Arrangement

- Row-Major Ordering

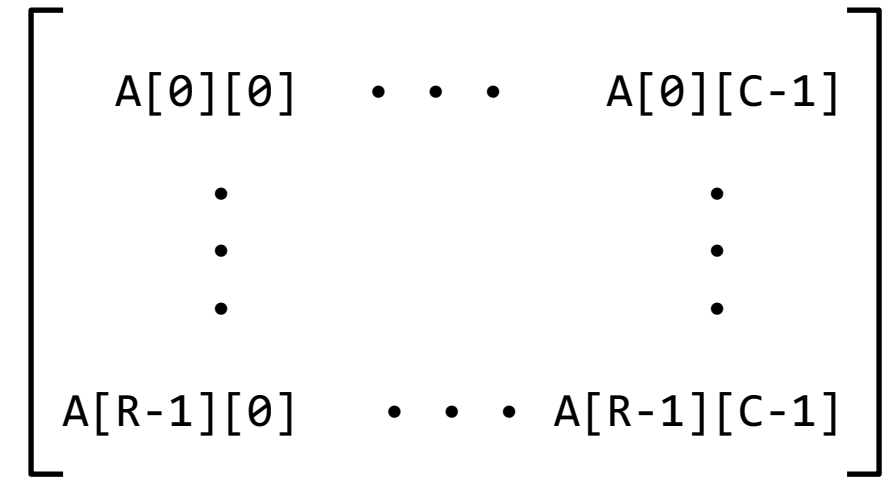

```
int A[R][C];
```

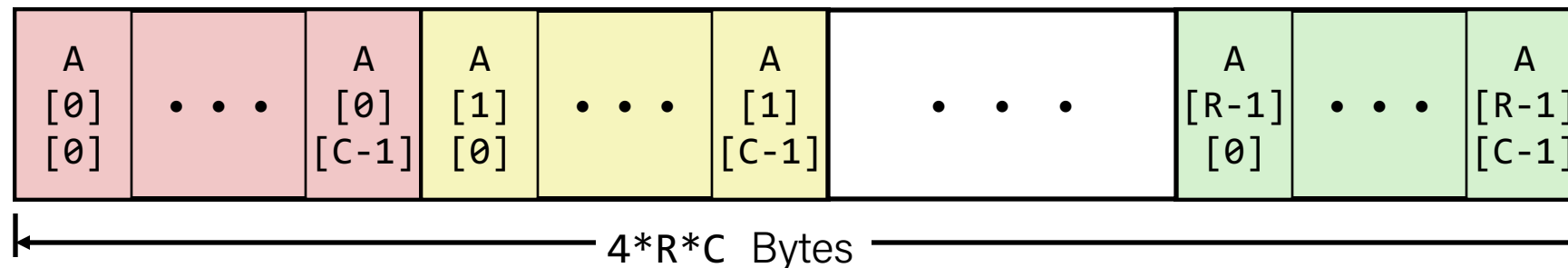

Recap: Multi-Level Array Example

```
zip_dig cmu = { 1, 5, 2, 1, 3 };  
zip_dig mit = { 0, 2, 1, 3, 9 };  
zip_dig ku  = { 3, 4, 4, 5, 0 };
```

```
#define UCOUNT 3  
int *univ[UCOUNT] = {mit, cmu, ku};
```

- Variable `univ` denotes array of 3 elements
- Each element is a pointer
– 8 bytes
- Each pointer points to array of `int`'s

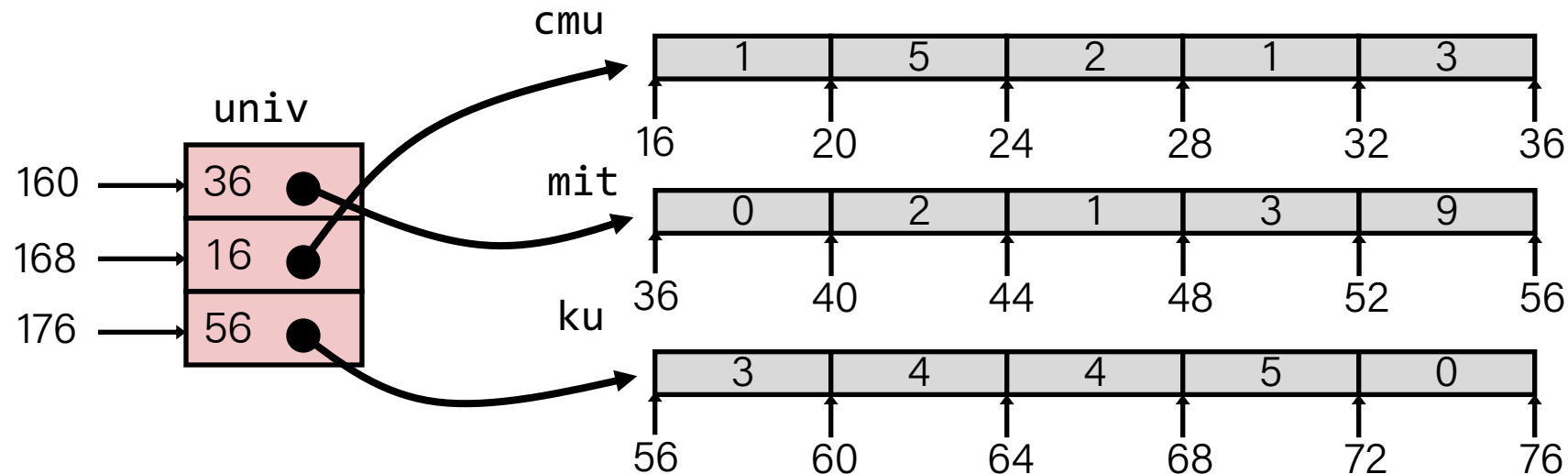

Recap: Array Element Accesses

Nested array

```
int get_pgh_digit  
  (size_t index, size_t digit)  
{  
  return pgh[index][digit];  
}
```

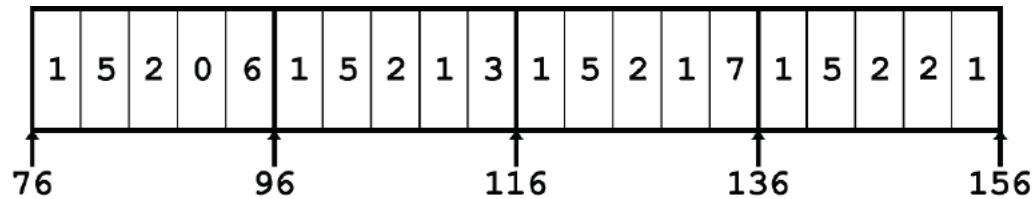

Multi-level array

```
int get_univ_digit  
  (size_t index, size_t digit)  
{  
  return univ[index][digit];  
}
```

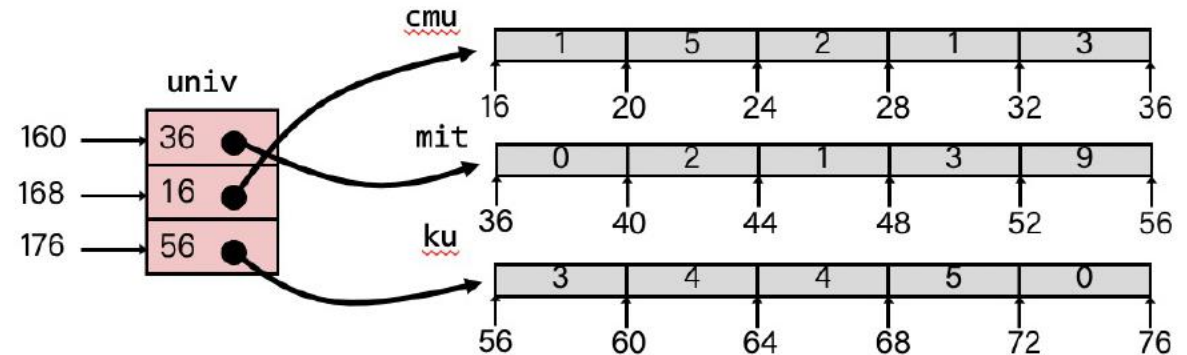

- Accesses looks similar in C, but address computations very different:

$\text{Mem}[\text{pgh} + 20 * \text{index} + 4 * \text{digit}]$

$\text{Mem}[\text{Mem}[\text{univ} + 8 * \text{index}] + 4 * \text{digit}]$

Recap: Structures & Alignment

```
struct S1 {  
    char c;  
    int i[2];  
    double v;  
} *p;
```

Unaligned Data

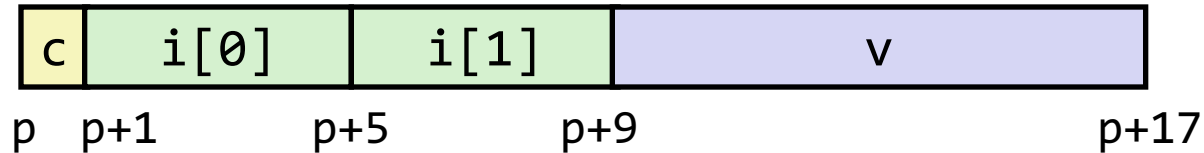

Aligned Data

- Primitive data type requires K bytes
- Address must be multiple of K

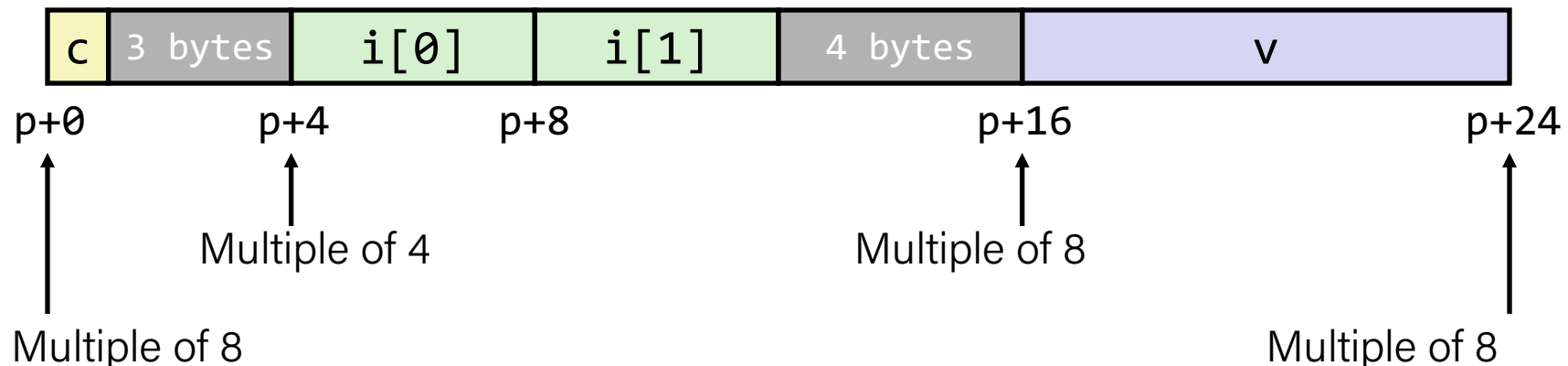

Recap: Specific Cases of Alignment (x86-64)

- 1 byte: `char`, ...
 - no restrictions on address
- 2 bytes: `short`, ...
 - lowest 1 bit of address must be 0_2
- 4 bytes: `int`, `float`, ...
 - lowest 2 bits of address must be 00_2
- 8 bytes: `double`, `long`, `char *`, ...
 - lowest 3 bits of address must be 000_2
- 16 bytes: `long double` (GCC on Linux)
 - lowest 4 bits of address must be 0000_2

Recap: Satisfying Alignment with Structures

Within structure:

- Must satisfy each element's alignment requirement

Overall structure placement

- Each structure has alignment requirement K
 - $K =$ Largest alignment of any element
- Initial address & structure length must be multiples of K

```
struct S1 {  
    char c;  
    int i[2];  
    double v;  
} *p;
```

Example:

- $K = 8$, due to **double** element

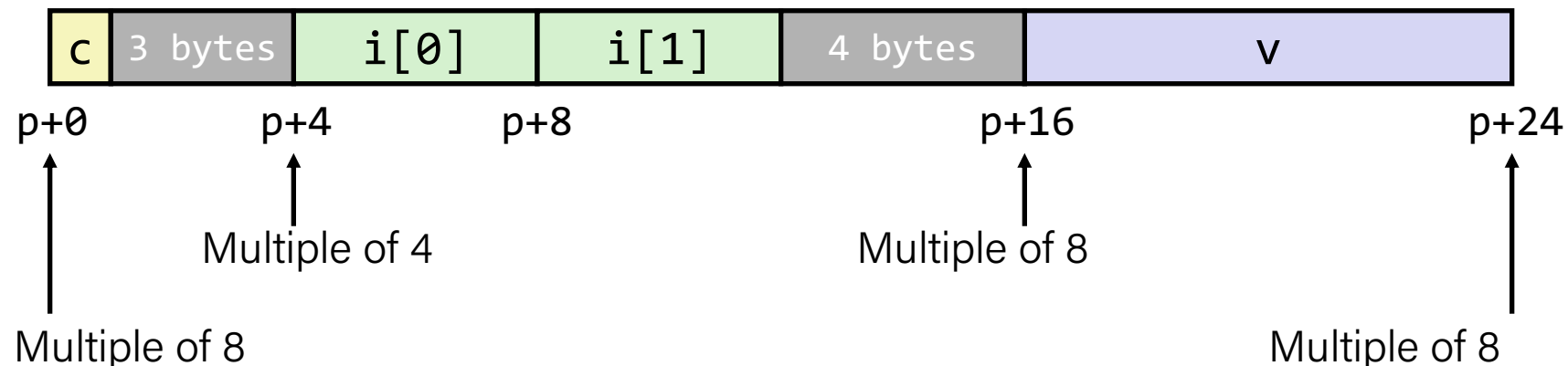

Recap: Overall Alignment Requirement

- For largest alignment requirement K
- Overall structure must be multiple of K

```
struct S2 {  
    double v;  
    int i[2];  
    char c;  
} *p;
```

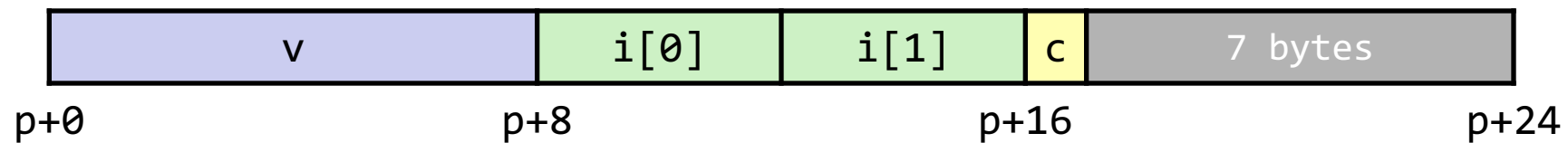

Multiple of $K=8$

Recap: Arrays of Structures

- Overall structure length multiple of K
- Satisfy alignment requirement for every element

```
struct S2 {  
    double v;  
    int i[2];  
    char c;  
} a[10];
```

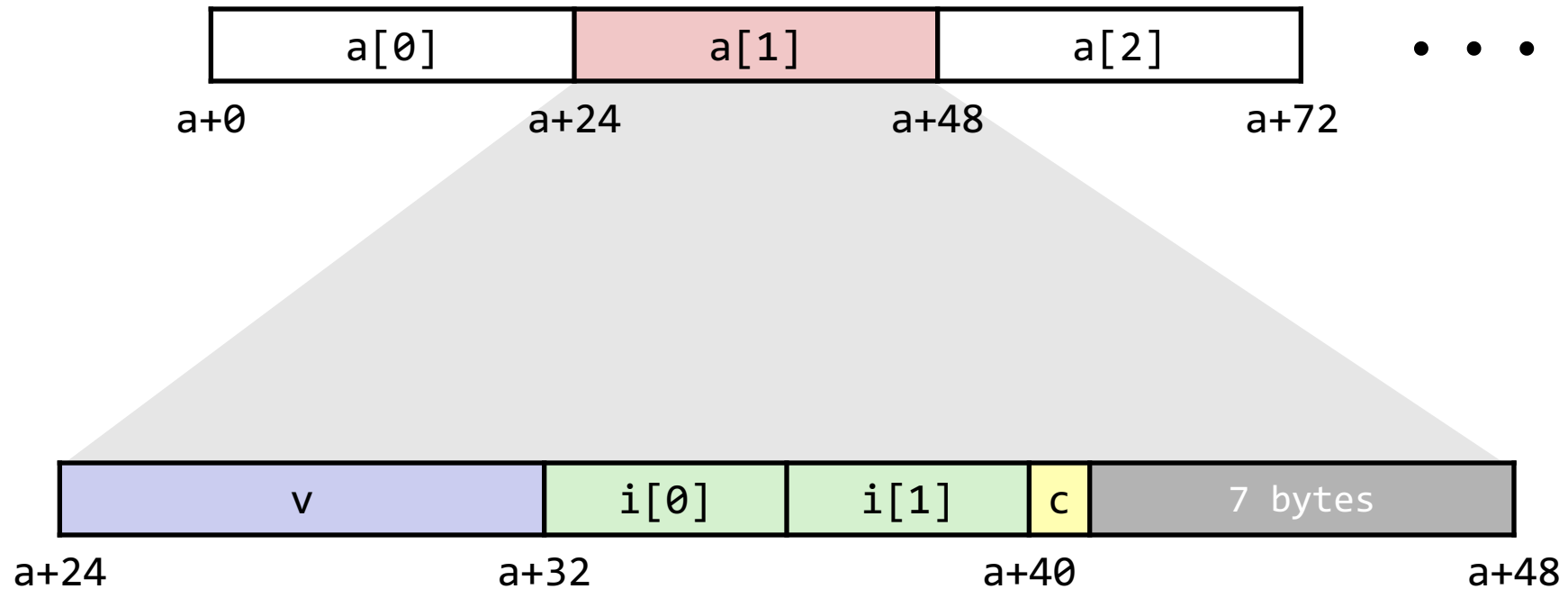

Recap: Accessing Array Elements

- Compute array offset $12 * \text{idx}$
 - `sizeof(S3)`, including alignment spacers
- Element `j` is at offset 8 within structure
- Assembler gives offset `a+8` (resolved during linking)

```
struct S3 {  
    short i;  
    float v;  
    short j;  
} a[10];
```

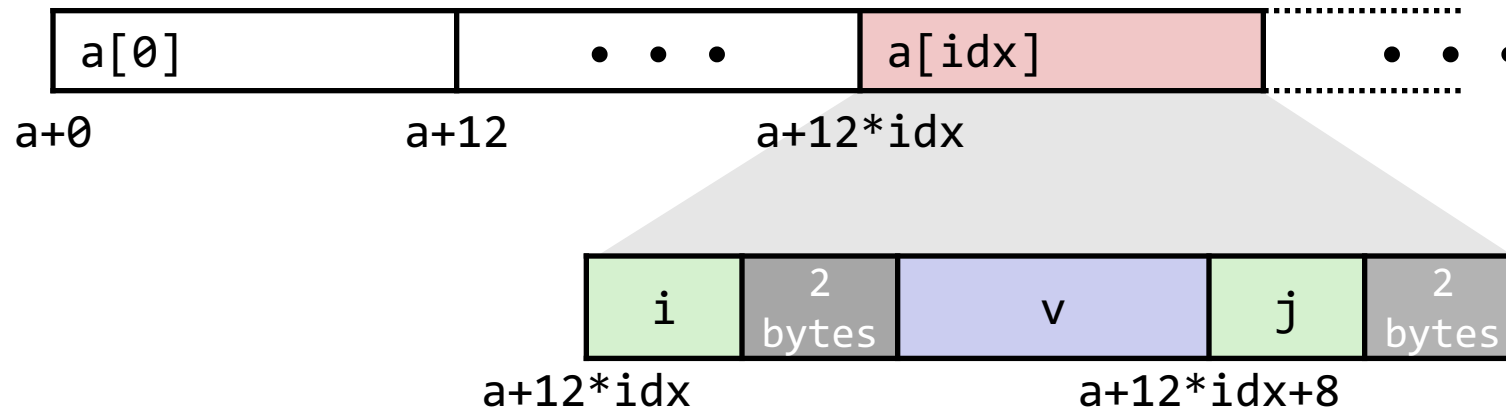

```
short get_j(int idx) {  
    return a[idx].j;  
}
```

```
# %rdi = idx  
leaq (%rdi,%rdi,2),%rax # 3*idx  
movzwl a+8(,%rax,4),%eax
```

Practice: Alignment

Determine the offset of each field, the total size of the structure, and its alignment requirement for x86-64.

```
struct mystruct {  
    int *a;  
    float b;  
    char c;  
    short d;  
    float e;  
    double f;  
    int g;  
    char *h;  
};
```

Field	*a	b	c	d	e	f	g	*h	Total	Alignment
Size	8	4	1	2	4	8	4	8	48	8
Offset	0	8	12	14	16	24	32	36	4 bytes padded to satisfy alignment requirement	

Rearranged structure with minimum wasted space:

Field	*a	f	h	b	e	g	d	c	Total	Alignment
Size	8	8	8	4	4	4	2	1	40	8
Offset	0	8	16	24	28	32	36	38	1 bytes padded to satisfy alignment requirement	

Plan for Today

- Floating Point
- Memory Layout
- Buffer Overflow

Disclaimer: Slides for this lecture were borrowed from

—Randal E. Bryant and David R. O'Hallaron's CMU 15-213 class

—Ruth Anderson's UW CSE 351 class

Lecture Plan

- Floating Point
- Memory Layout
- Buffer Overflow

Background

- History
 - x87 FP
 - Legacy, very ugly
 - Streaming SIMD Extensions (SSE) FP
 - SIMD: single instruction, multiple data
 - Special case use of vector instructions
 - AVX FP
 - Newest version
 - Similar to SSE
 - Documented in book

Programming with SSE3

XMM Registers

- 16 total, each 16 bytes
- 16 single-byte integers
- 8 16-bit integers
- 4 32-bit integers
- 4 single-precision floats
- 2 double-precision floats
- 1 single-precision float
- 1 double-precision float



Scalar & SIMD Operations

- Scalar Operations:
Single Precision

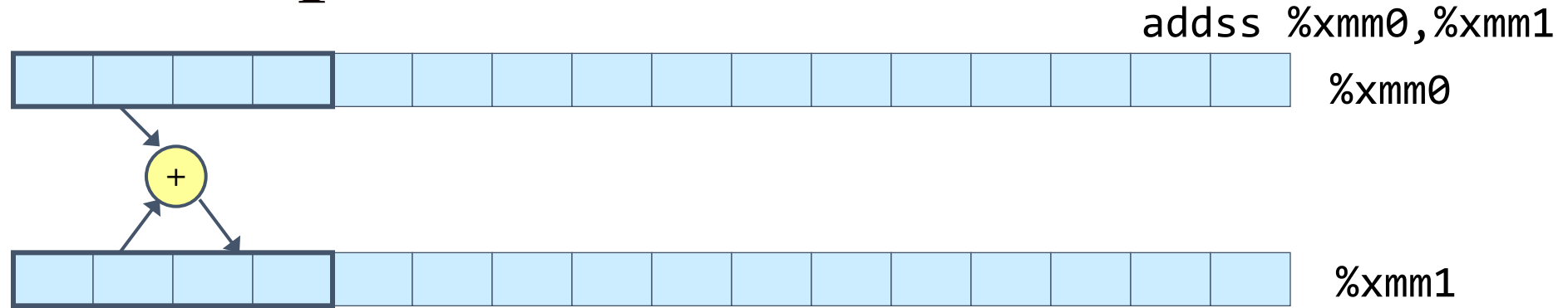

- SIMD Operations:
Single Precision

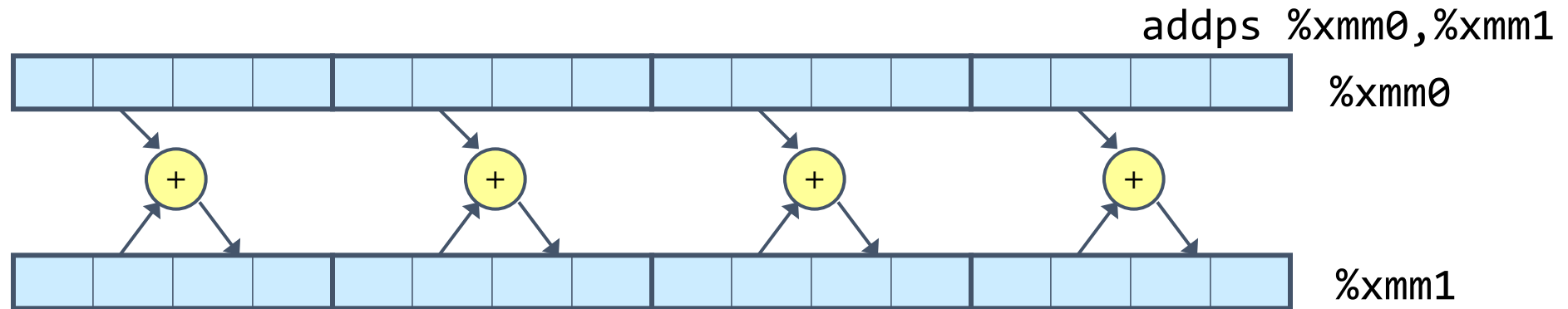

- Scalar Operations:
Double Precision

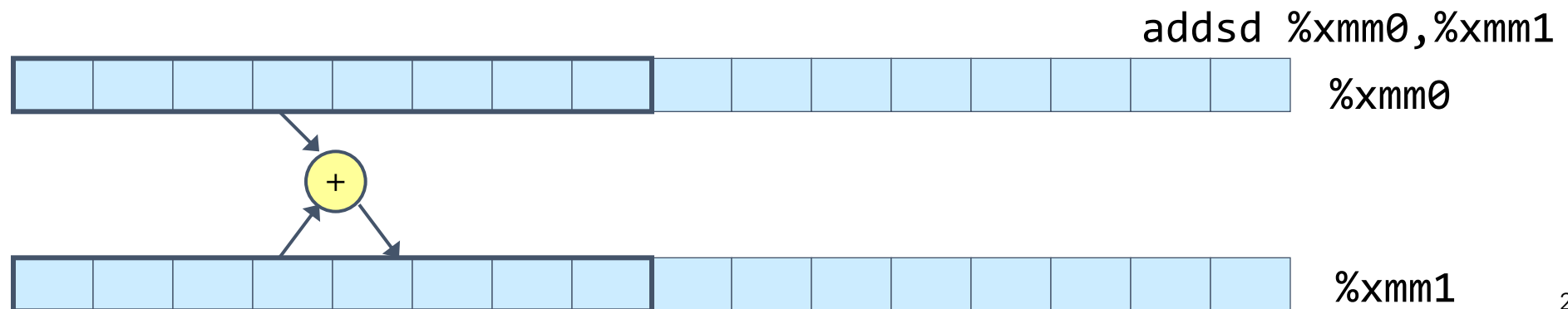

FP Basics

- Arguments passed in %xmm0, %xmm1, ...
- Result returned in %xmm0
- All XMM registers caller-saved

```
float fadd(float x, float y) {  
    return x + y;  
}
```

```
# x in %xmm0, y in %xmm1  
addss    %xmm1, %xmm0  
ret
```

```
double dadd(double x, double y) {  
    return x + y;  
}
```

```
# x in %xmm0, y in %xmm1  
addsd    %xmm1, %xmm0  
ret
```

FP Memory Referencing

- Integer (and pointer) arguments passed in regular registers
- FP values passed in XMM registers
- Different `mov` instructions to move between XMM registers, and between memory and XMM registers

```
double dincr(double *p, double v)
{
    double x = *p;
    *p = x + v;
    return x;
}
```

```
# p in %rdi, v in %xmm0
movapd  %xmm0, %xmm1    # Copy v
movsd   (%rdi), %xmm0   # x = *p
addsd   %xmm0, %xmm1    # t = x + v
movsd   %xmm1, (%rdi)   # *p = t
ret
```

Other Aspects of FP Code

- Lots of instructions
 - Different operations, different formats, ...
- Floating-point comparisons
 - Instructions `ucomiss` and `ucomisd`
 - Set condition codes `CF`, `ZF`, and `PF`
- Using constant values
 - Set `XMM0` register to 0 with instruction `xorpd %xmm0, %xmm0`
 - Others loaded from memory

Lecture Plan

- Floating Point
- Memory Layout
- Buffer Overflow

x86-64 Linux Memory Layout

- Stack
 - Runtime stack (8MB limit)
 - E.g., local variables
- Heap
 - Dynamically allocated as needed
 - When call `malloc()`, `calloc()`, `new()`
- Data
 - Statically allocated data
 - E.g., global variables, `static` variables, string constants
- Text / Shared Libraries
 - Executable machine instructions
 - Read-only

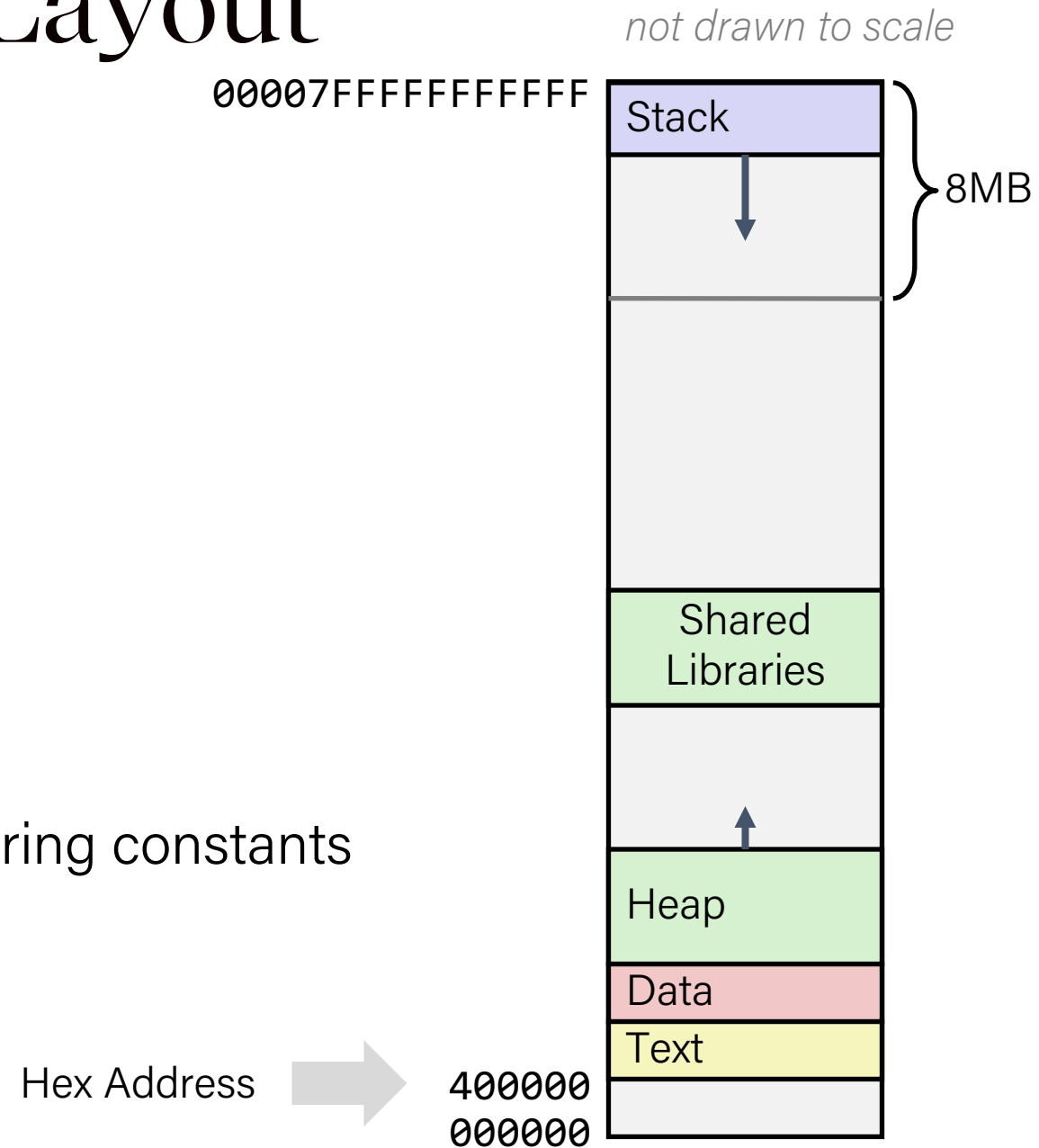

Memory Allocation Example

```
char big_array[1L<<24]; /* 16 MB */
char huge_array[1L<<31]; /* 2 GB */

int global = 0;

int useless() { return 0; }

int main ()
{
    void *p1, *p2, *p3, *p4;
    int local = 0;
    p1 = malloc(1L << 28); /* 256 MB */
    p2 = malloc(1L << 8); /* 256 B */
    p3 = malloc(1L << 32); /* 4 GB */
    p4 = malloc(1L << 8); /* 256 B */
    /* Some print statements ... */
}
```

- Where does everything go?

not drawn to scale

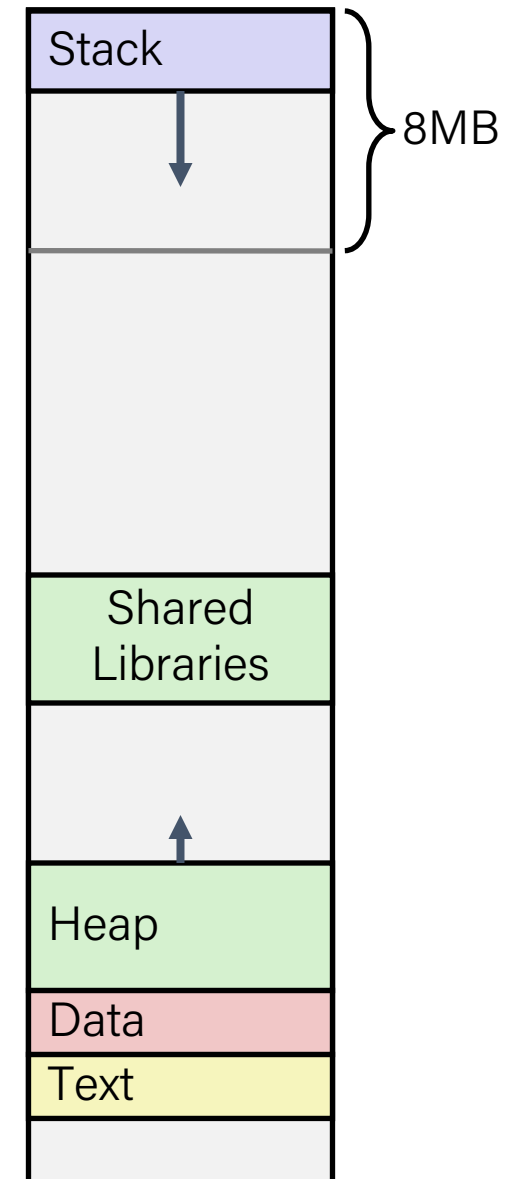

x86-64 Example Addresses

address range $\sim 2^{47}$

local

0x00007ffe4d3be87c

p1

0x00007f7262a1e010

p3

0x00007f7162a1d010

p4

0x000000008359d120

p2

0x000000008359d010

big_array

0x0000000080601060

huge_array

0x0000000000601060

main()

0x000000000040060c

useless()

0x0000000000400590

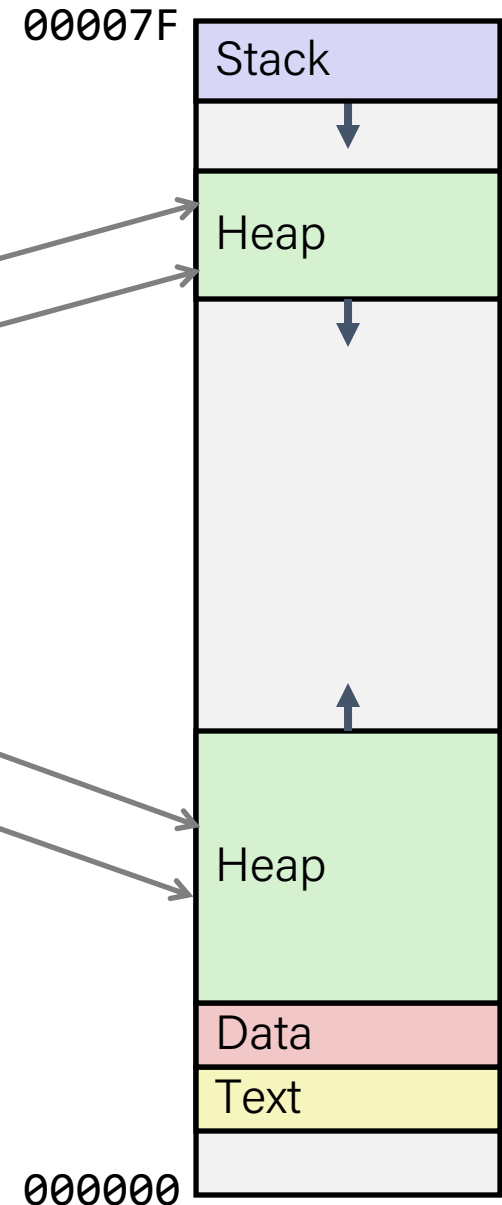

Reminder: x86-64/Linux Stack Frame

- **Caller's Stack Frame**

- Arguments (if > 6 args) for this call

- **Current/ Callee Stack Frame**

- Return address
 - Pushed by `call` instruction
- Old frame pointer (optional)
- Caller-saved pushed before setting up arguments for a function call
- Callee-saved pushed before using long-term registers
- Local variables (if can't be kept in registers)
- "Argument build" area (Need to call a function with >6 arguments? Put them here)

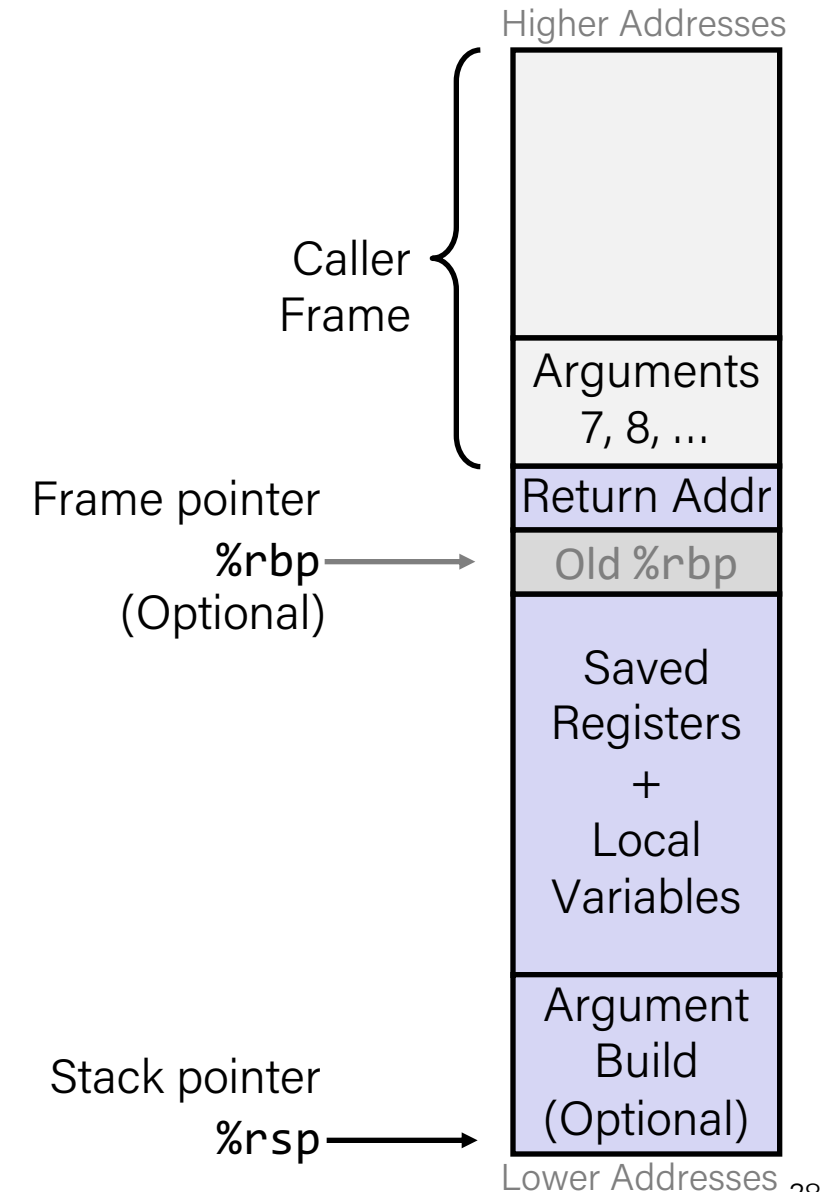

Lecture Plan

- Floating Point
- Memory Layout
- Buffer Overflow
 - Vulnerability
 - Protection

Memory Referencing Bug Example

```
typedef struct {
    int a[2];
    double d;
} struct_t;

double fun(int i) {
    volatile struct_t s;
    s.d = 3.14;
    s.a[i] = 1073741824; /* Possibly out of bounds */
    return s.d;
}
```

fun(0) → 3.14

fun(1) → 3.14

fun(2) → 3.1399998664856

fun(3) → 2.00000061035156

fun(4) → 3.14

fun(6) → Segmentation fault

Result is system specific

Memory Referencing Bug Example

```
typedef struct {  
    int a[2];  
    double d;  
} struct_t;
```

```
fun(0) → 3.14  
fun(1) → 3.14  
fun(2) → 3.1399998664856  
fun(3) → 2.00000061035156  
fun(4) → 3.14  
fun(6) → Segmentation fault
```

Explanation:

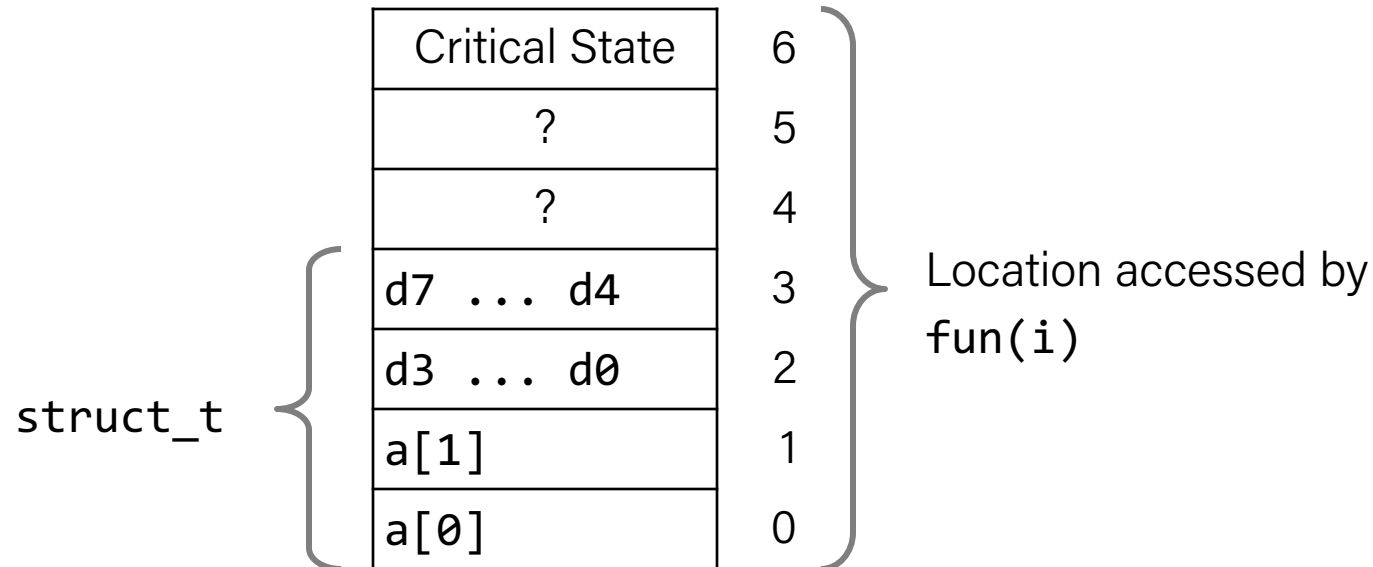

Buffer Overflow in a Nutshell

- C does not check array bounds
 - Many Unix/Linux/C functions don't check argument sizes
 - Allows overflowing (writing past the end) of buffers (arrays)
- "Buffer Overflow" = Writing past the end of an array
- Characteristics of the traditional Linux memory layout provide opportunities for malicious programs
 - Stack grows "backwards" in memory
 - Data and instructions both stored in the same memory

Recap: COMP201 Learning Goals

(also learn to identify legitimate programmer scenes in Hollywood movies)



Jeff Goldblum's character saving the world by uploading a virus to the alien mothership
Independence Day, 1996

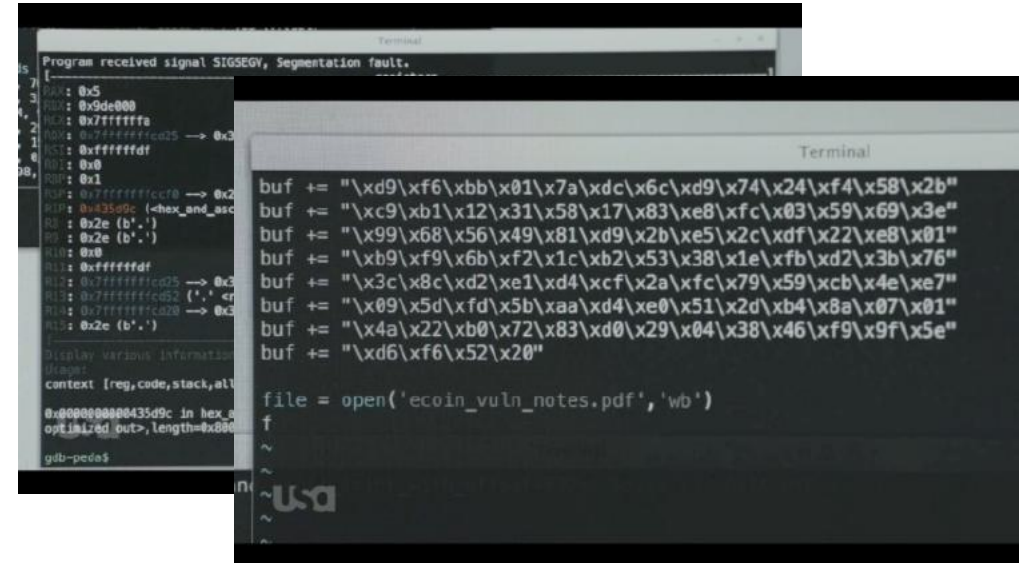

Elliot creating a malicious PDF file, which contains some sort of shellcode that will allow him to take over any Linux computer that opens that file in Evince.
Mr. Robot, S3, Ep9 - eps3.8_stage3.torrent (2017)

String Library Code

- Implementation of Unix function `gets()`

```
/* Get string from stdin */
char *gets(char *dest)
{
    int c = getchar();
    char *p = dest;
    while (c != EOF && c != '\n') {
        *p++ = c;
        c = getchar();
    }
    *p = '\0';
    return dest;
}
```

- No way to specify limit on number of characters to read
- Similar problems with other library functions
 - `strcpy`, `strcat`: Copy strings of arbitrary length
 - `scanf`, `fscanf`, `sscanf`, when given `%s` conversion specification

Vulnerable Buffer Code

```
/* Echo Line */
void echo()
{
    char buf[4]; /* Way too small! */
    gets(buf);
    puts(buf);
}

void call_echo() {
    echo();
}
```

↑
**btw, how big
is big enough?**

```
unix>./bufdemo-nsp
Type a string:
012345678901234567890123
012345678901234567890123
```

```
unix>./bufdemo-nsp
Type a string:
0123456789012345678901234
Segmentation Fault
```

Buffer Overflow Disassembly

echo:

0000000004006cf <echo>:

4006cf: 48 83 ec 18	sub	\$0x18,%rsp
4006d3: 48 89 e7	mov	%rsp,%rdi
4006d6: e8 a5 ff ff ff	callq	400680 <gets>
4006db: 48 89 e7	mov	%rsp,%rdi
4006de: e8 3d fe ff ff	callq	400520 <puts@plt>
4006e3: 48 83 c4 18	add	\$0x18,%rsp
4006e7: c3	retq	

call_echo:

4006e8: 48 83 ec 08	sub	\$0x8,%rsp
4006ec: b8 00 00 00 00	mov	\$0x0,%eax
4006f1: e8 d9 ff ff ff	callq	4006cf <echo>
4006f6: 48 83 c4 08	add	\$0x8,%rsp
4006fa: c3	retq	

Buffer Overflow Stack

Before call to gets

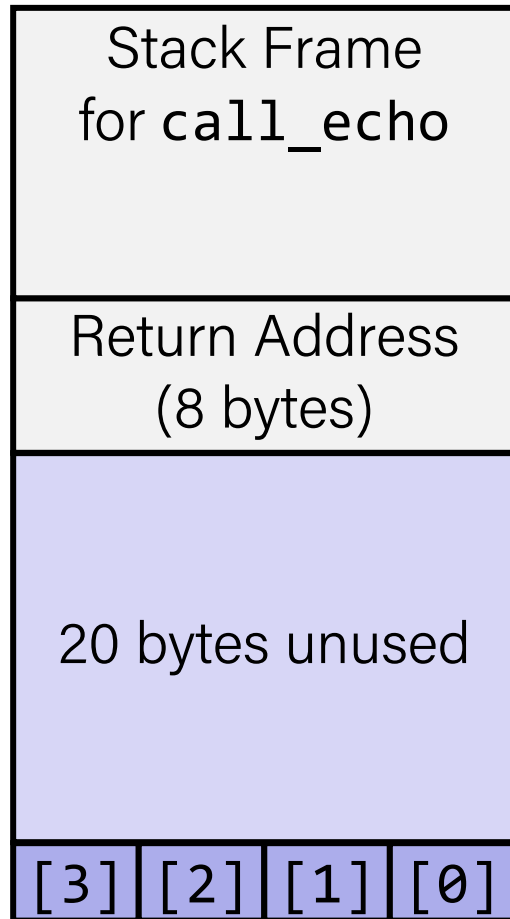

```
/* Echo Line */  
void echo()  
{  
    char buf[4]; /* Way too small! */  
    gets(buf);  
    puts(buf);  
}
```

```
echo:  
    subq    $24, %rsp  
    movq    %rsp, %rdi  
    call   gets  
    . . .
```

Buffer Overflow Stack Example

Before call to gets

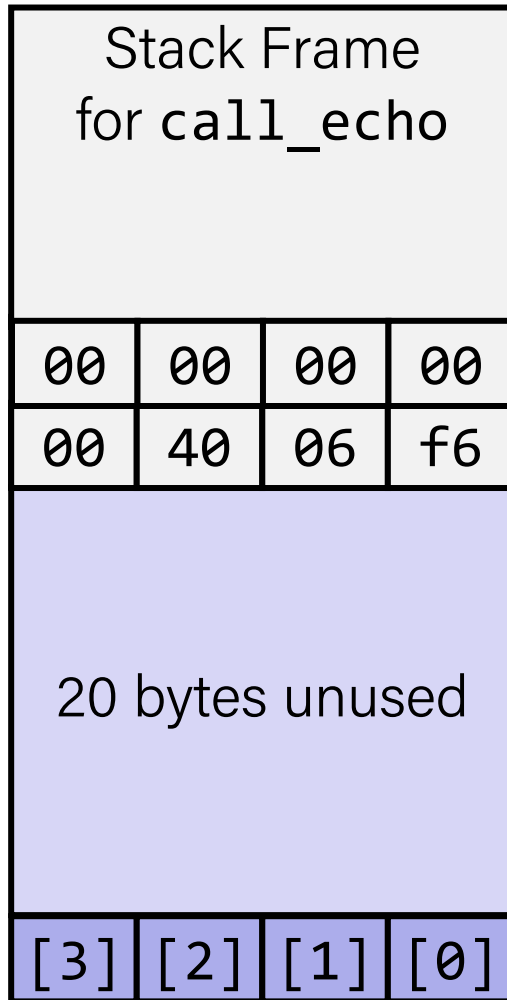

```
void echo()  
{  
    char buf[4];  
    gets(buf);  
    . . .  
}
```

```
echo:  
    subq $24, %rsp  
    movq %rsp,  
%rdi  
    call gets  
    . . .
```

call_echo:

```
. . .  
4006f1: callq 4006cf <echo>  
4006f6: add $0x8,%rsp  
. . .
```

Buffer Overflow Stack Example #1

After call to gets

Stack Frame for call_echo			
00	00	00	00
00	40	06	f6
00	32	31	30
39	38	37	36
35	34	33	32
31	30	39	38
37	36	35	34
33	32	31	30

buf ← %rsp

```
void echo()
{
    char buf[4];
    gets(buf);
    . . .
}
```

```
echo:
    subq $24, %rsp
    movq %rsp,
%rdi
    call gets
    . . .
```

```
call_echo:
    . . .
4006f1: callq 4006cf <echo>
4006f6: add $0x8,%rsp
    . . .
```

```
unix>./bufdemo-nsp
Type a string:
01234567890123456789012
01234567890123456789012
```

Overflowed buffer, but did not corrupt state

Buffer Overflow Stack Example #2

After call to gets

Stack Frame for call_echo			
00	00	00	00
00	40	00	34
33	32	31	30
39	38	37	36
35	34	33	32
31	30	39	38
37	36	35	34
33	32	31	30

buf ← %rsp

```
void echo()
{
    char buf[4];
    gets(buf);
    . . .
}
```

```
echo:
    subq $24, %rsp
    movq %rsp,
%rdi
    call gets
    . . .
```

call_echo:

```
. . .
4006f1: callq 4006cf <echo>
4006f6: add $0x8,%rsp
. . .
```

```
unix>./bufdemo-nspunix>./bufdemo-nsp
Type a string:
0123456789012345678901234
Segmentation Fault
```

Overflowed buffer and corrupted return pointer

Buffer Overflow Stack Example #3

After call to gets

Stack Frame for call_echo			
00	00	00	00
00	40	06	00
33	32	31	30
39	38	37	36
35	34	33	32
31	30	39	38
37	36	35	34
33	32	31	30

buf ← %rsp

```
void echo()
{
    char buf[4];
    gets(buf);
    . . .
}
```

```
echo:
    subq $24, %rsp
    movq %rsp,
%rdi
    call gets
    . . .
```

```
call_echo:
    . . .
4006f1: callq 4006cf <echo>
4006f6: add $0x8,%rsp
    . . .
```

```
unix>./bufdemo-nsp
Type a string:
012345678901234567890123
012345678901234567890123
```

Overflowed buffer, corrupted return pointer, but program seems to work!

Buffer Overflow Stack Example #3 Explained

After call to gets

Stack Frame for call_echo			
00	00	00	00
00	40	06	00
33	32	31	30
39	38	37	36
35	34	33	32
31	30	39	38
37	36	35	34
33	32	31	30

register_tm_clones:

```
. . .  
400600: mov    %rsp,%rbp  
400603: mov    %rax,%rdx  
400606: shr   $0x3f,%rdx  
40060a: add   %rdx,%rax  
40060d: sar   %rax  
400610: jne   400614  
400612: pop   %rbp  
400613: retq
```

“Returns” to unrelated code

Lots of things happen, without modifying critical state

Eventually executes retq back to main

buf ← %rsp

Why is buffer overflow a big deal?

- Buffer overflows on the stack can overwrite “interesting” data
 - Attackers just choose the right inputs
- Simplest form (sometimes called “stack smashing”)
 - Unchecked length on string input into bounded array causes overwriting of stack data
 - Try to change the return address of the current procedure
- Why is this a big deal?
 - It was the #1 *technical* cause of security vulnerabilities
 - #1 *overall* cause is social engineering / user ignorance

Code Injection Attacks

```
void P(){  
    Q();  
    ... ← return  
}          address A  
  
int Q() {  
    char buf[64];  
    gets(buf);  
    ...  
    return ...;  
}
```

- Input string contains byte representation of executable code
- Overwrite return address A with address of buffer B
- When Q executes `ret`, will jump to exploit code

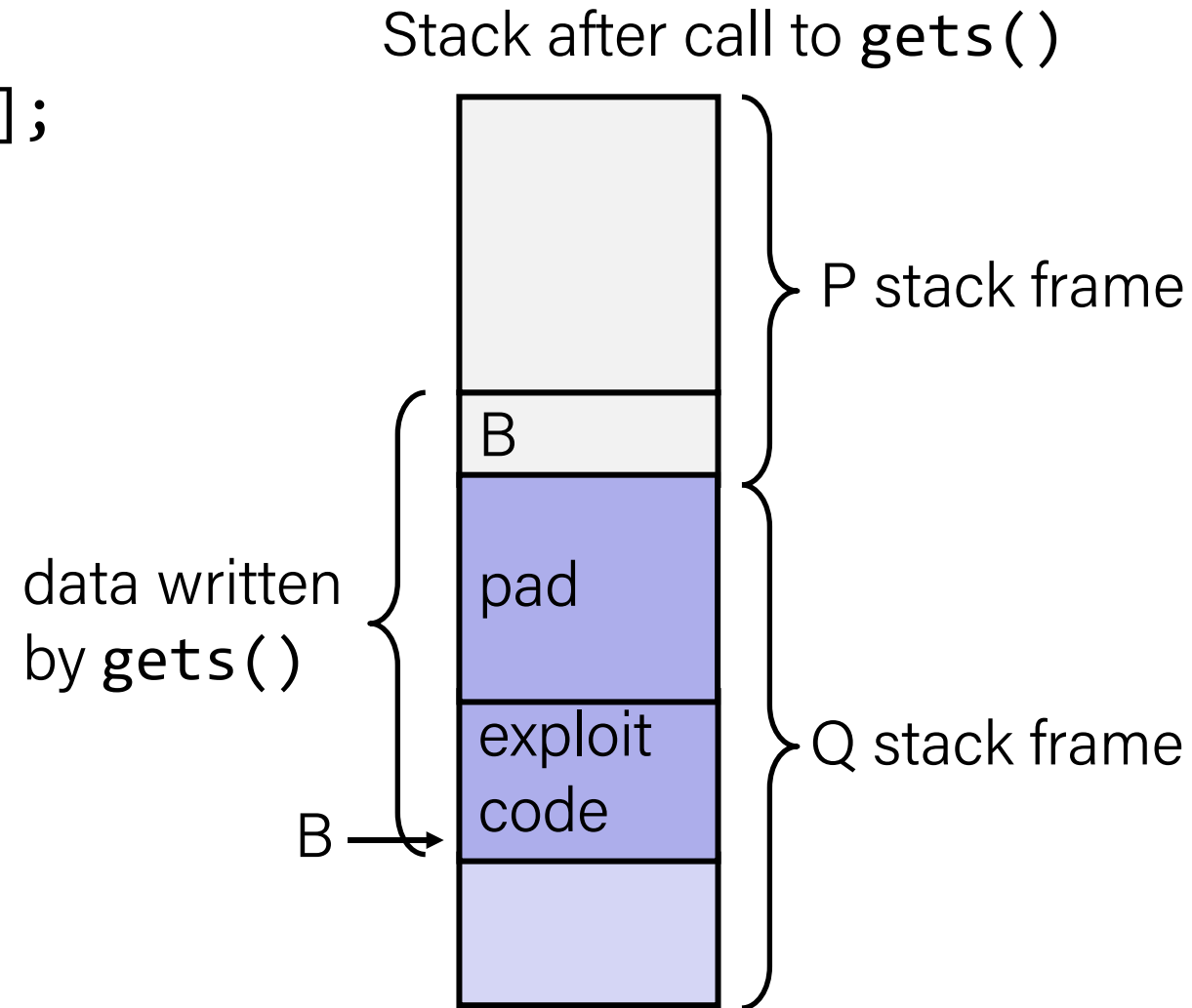

Malicious Use of Buffer Overflow: Code Injection Attacks

```
void foo(){  
    bar();  
A:... ← return address A  
}
```

```
int bar() {  
    char buf[64];  
    gets(buf);  
    ...  
    return ...;  
}
```

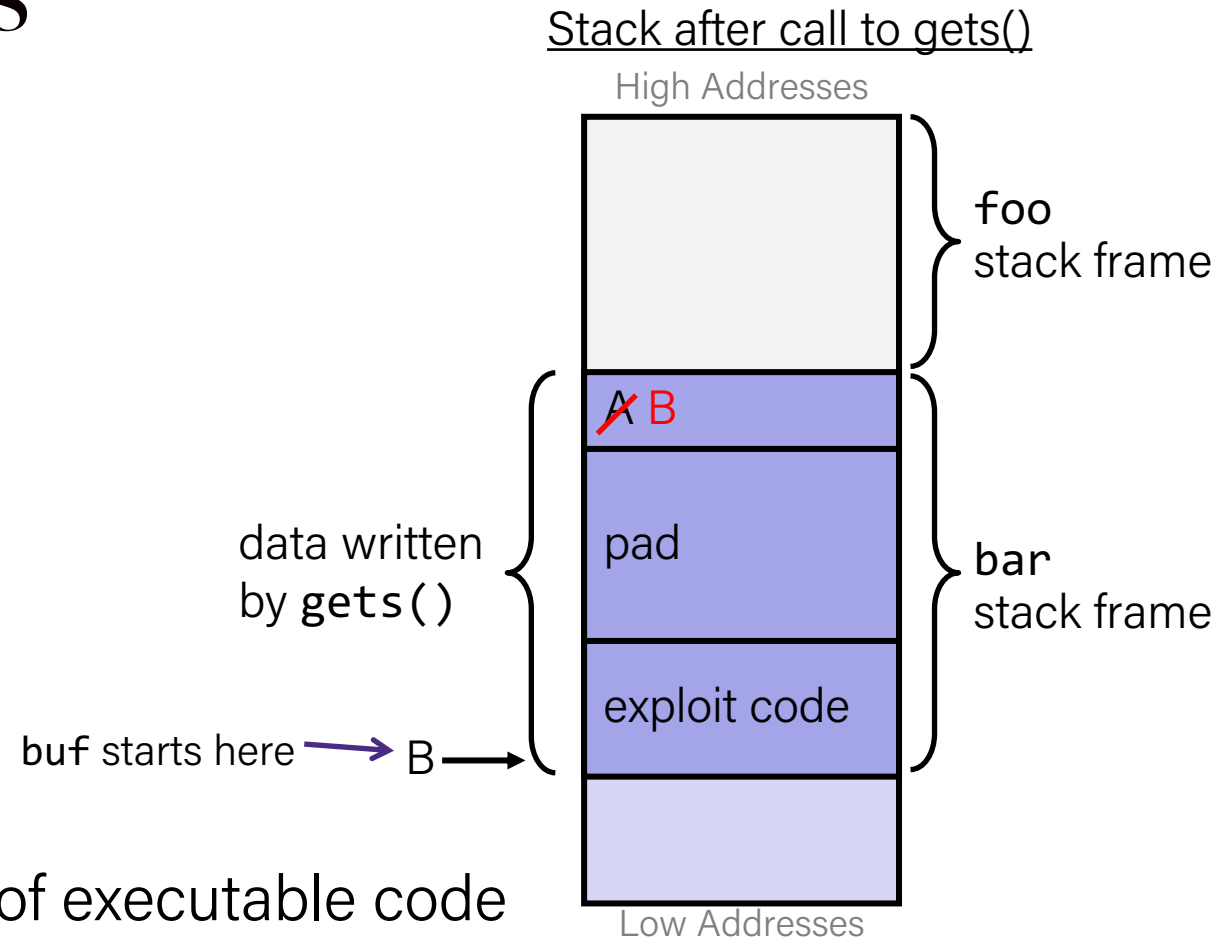

- Input string contains byte representation of executable code
- Overwrite return address A with address of buffer B
- When `bar()` executes `ret`, will jump to exploit code

Question

- `smash_me` is vulnerable to stack smashing!
- What is the minimum number of characters that `gets` must read in order for us to change the return address to a stack address?
 - For example: (0x00 00 7f ff CA FE F0 0D)

Always 0's

Previous stack frame			
00	00	00	00
00	40	05	d1
...			
			[0]

```
smash_me:
  subq  $0x40, %rsp
  ...
  leaq  16(%rsp), %rdi
  call  gets
  ...
```

- A. 27
- B. 30
- C. 51
- D. 54
- E. We're lost...

Question

- `smash_me` is vulnerable to stack smashing!
- What is the minimum number of characters that `gets` must read in order for us to change the return address to a stack address?
 - For example: (0x00 00 7f ff CA FE F0 0D)

Always 0's

Previous stack frame			
00	00	00	00
00	40	05	d1
...			
			[0]

```
smash_me:
  subq  $0x40, %rsp
  ...
  leaq  16(%rsp), %rdi
  call  gets
  ...
```

A. 27

B. 30

C. 51

D. 54 = 64 - 16 + 6

E. We're lost...

Exploits Based on Buffer Overflows

- **Buffer overflow bugs can allow remote machines to execute arbitrary code on victim machines**
- Distressingly common in real programs
 - Programmers keep making the same mistakes 😞
 - Recent measures make these attacks much more difficult
- Examples across the decades
 - Original “Internet worm” (1988)
 - “IM wars” (1999)
 - Twilight hack on Wii (2000s)
 - Hacking embedding devices (e.g. cars, smart homes, planes)
- You will learn some of the tricks in Assignment 4
 - Hopefully to convince you to never leave such holes in your programs!!

Example: the original Internet worm (1988)

- Exploited a few vulnerabilities to spread
 - Early versions of the finger server (fingerd) used `gets()` to read the argument sent by the client:
 - `finger droh@linuxpool.ku.edu.tr`
 - Worm attacked fingerd server by sending phony argument:
 - `finger "exploit-code padding new-return-address"`
 - exploit code: executed a root shell on the victim machine with a direct TCP connection to the attacker.
- Once on a machine, scanned for other machines to attack
 - invaded ~6000 computers in hours (10% of the Internet 😊)
 - see June 1989 article in Comm. of the ACM
 - the young author of the worm was prosecuted...
 - and CERT was formed... homed at CMU

Example 2: IM War

July 1999:

- Microsoft launches MSN Messenger (instant messaging system).
- Messenger clients can access popular AOL Instant Messaging Service (AIM) servers

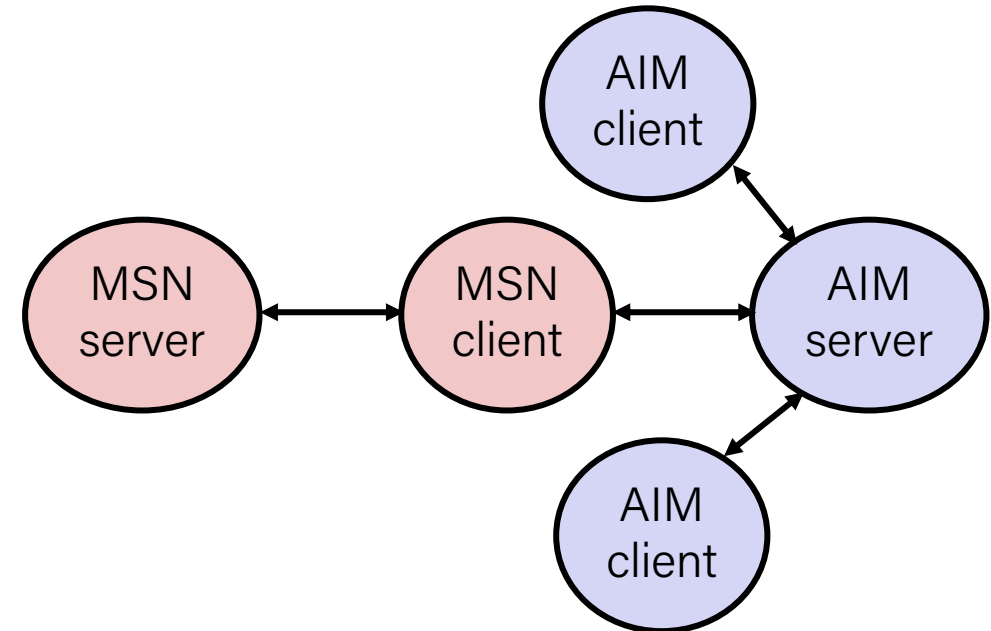

IM War (cont.)

August 1999:

- Mysteriously, Messenger clients can no longer access AIM servers
- Microsoft and AOL begin the IM war:
 - AOL changes server to disallow Messenger clients
 - Microsoft makes changes to clients to defeat AOL changes
 - At least 13 such skirmishes
- What was really happening?
 - AOL had discovered a buffer overflow bug in their own AIM clients
 - They exploited it to detect and block Microsoft: the exploit code returned a 4-byte signature (the bytes at some location in the AIM client) to server
 - When Microsoft changed code to match signature, AOL changed signature location

Date: Wed, 11 Aug 1999 11:30:57 -0700 (PDT)
From: Phil Bucking <philbucking@yahoo.com>
Subject: AOL exploiting buffer overrun bug in their own software!
To: rms@pharlap.com

Mr. Smith,

I am writing you because I have discovered something that I think you might find interesting because you are an Internet security expert with experience in this area. I have also tried to contact AOL but received no response.

I am a developer who has been working on a revolutionary new instant messaging client that should be released later this year.

...
It appears that the AIM client has a buffer overrun bug. By itself this might not be the end of the world, as MS surely has had its share. But AOL is now *exploiting their own buffer overrun bug* to help in its efforts to block MS Instant Messenger.

....
Since you have significant credibility with the press I hope that you can use this information to help inform people that behind AOL's friendly exterior they are nefariously compromising peoples' security.

Sincerely,
Phil Bucking
Founder, Bucking Consulting
philbucking@yahoo.com

***It was later determined
that this email originated
from within Microsoft!***

Aside: Worms and Viruses

- **Worm:** A program that
 - Can run by itself
 - Can propagate a fully working version of itself to other computers

- **Virus:** Code that
 - Adds itself to other programs
 - Does not run independently

- Both are (usually) designed to spread among computers and to wreak havoc

Hacking Cars

- UW CSE [research from 2010](#) demonstrated wirelessly hacking a car using buffer overflow
- Overwrote the onboard control system's code
 - Disable brakes
 - Unlock doors
 - Turn engine on/off



Flappy Bird in Super Mario World



SNES Code
Injection

53:27.59

This is a project to inject an entire game's source code (331 bytes) into unused portions of SNES system memory, and then run it, turning Super Mario World into a completely different game. What game? Watch and find out.

If I don't make any mistakes, it should take about an hour. If I make one mistake, the game will either crash, or I'll have to start the section over.

I've been planning this for several months with [p4plus2](#). Thanks also to [MrCheeze](#), without whom this route would not be possible.



<https://www.youtube.com/watch?v=hB6eY73sLV>

SethBling

OK, what to do about buffer overflow attacks

- Avoid overflow vulnerabilities
- Employ system-level protections
- Have compiler use “stack canaries”

1. Avoid Overflow Vulnerabilities in Code (!)

```
/* Echo Line */  
void echo()  
{  
    char buf[4]; /* Way too small! */  
    fgets(buf, 4, stdin);  
    puts(buf);  
}
```

For example, use library routines that limit string lengths

- `fgets` instead of `gets`
- `strncpy` instead of `strcpy`
- Don't use `scanf` with `%s` conversion specification
 - Use `fgets` to read the string
 - Or use `%ns` where `n` is a suitable integer

2. System-Level Protections can help

Randomized stack offsets

- At start of program, allocate random amount of space on stack
- Shifts stack addresses for entire program
- Makes it difficult for hacker to predict beginning of inserted code
- E.g.: 5 executions of memory allocation code

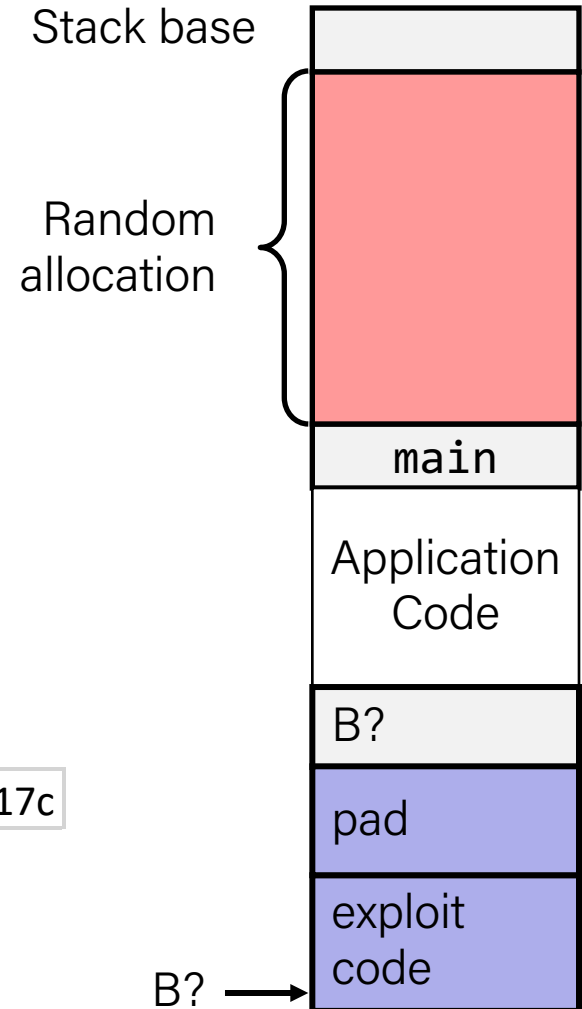

local	0x7ffe4d3be87c	0x7fff75a4f9fc	0x7ffeadb7c80c	0x7ffeaea2fdac	0x7ffcd452017c
-------	----------------	----------------	----------------	----------------	----------------

– Stack repositioned each time program executes

2. System-Level Protections can help

Nonexecutable code segments

- In traditional x86, can mark region of memory as either "read-only" or "writeable"
 - Can execute anything readable
- X86-64 added explicit "execute" permission
- Stack marked as non-executable

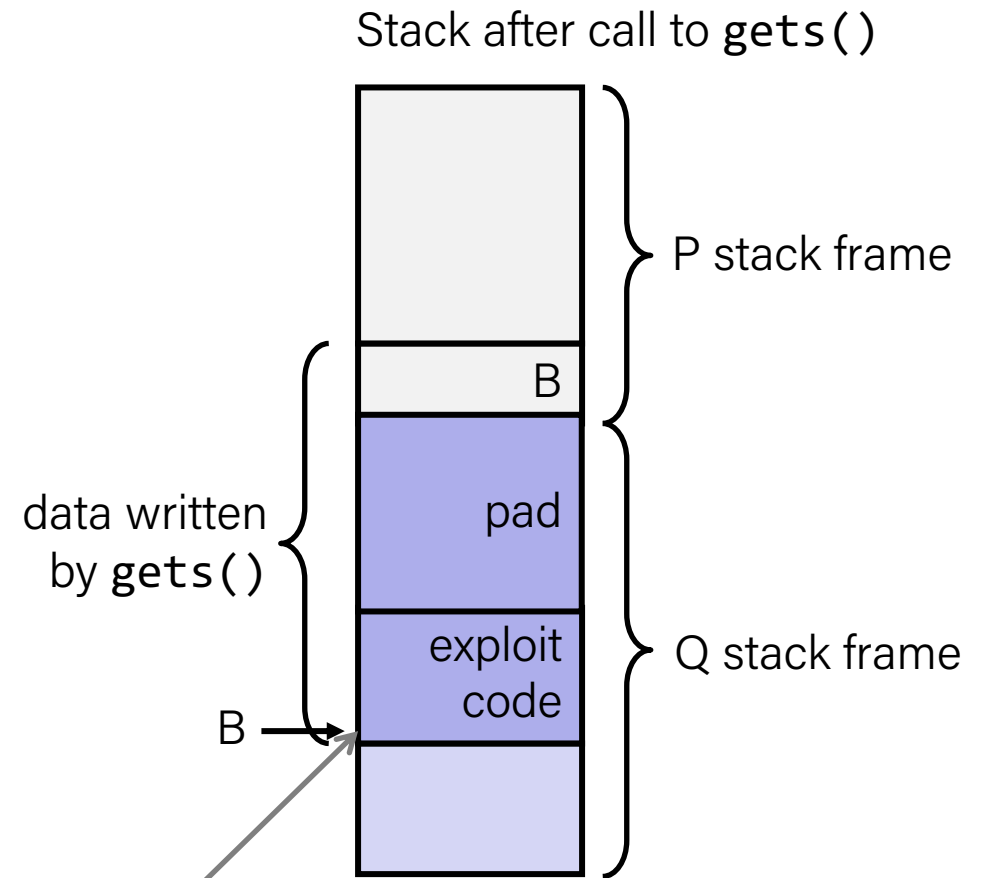

Any attempt to execute this code will fail

3. Stack Canaries can help

Idea:

- Place special value ("canary") on stack just beyond buffer
- Check for corruption before exiting function

GCC Implementation

- `-fstack-protector`
- Now the default (disabled earlier)

```
unix>./bufdemo-sp
Type a string:
0123456
0123456
```

```
unix>./bufdemo-sp
Type a string:
01234567
*** stack smashing detected ***
```

Protected Buffer Disassembly

echo:

```
40072f: sub    $0x18,%rsp
400733: mov    %fs:0x28,%rax
40073c: mov    %rax,0x8(%rsp)
400741: xor    %eax,%eax
400743: mov    %rsp,%rdi
400746: callq 4006e0 <gets>
40074b: mov    %rsp,%rdi
40074e: callq 400570 <puts@plt>
400753: mov    0x8(%rsp),%rax
400758: xor    %fs:0x28,%rax
400761: je     400768 <echo+0x39>
400763: callq 400580 <__stack_chk_fail@plt>
400768: add    $0x18,%rsp
40076c: retq
```

Setting Up Canary

Before call to gets

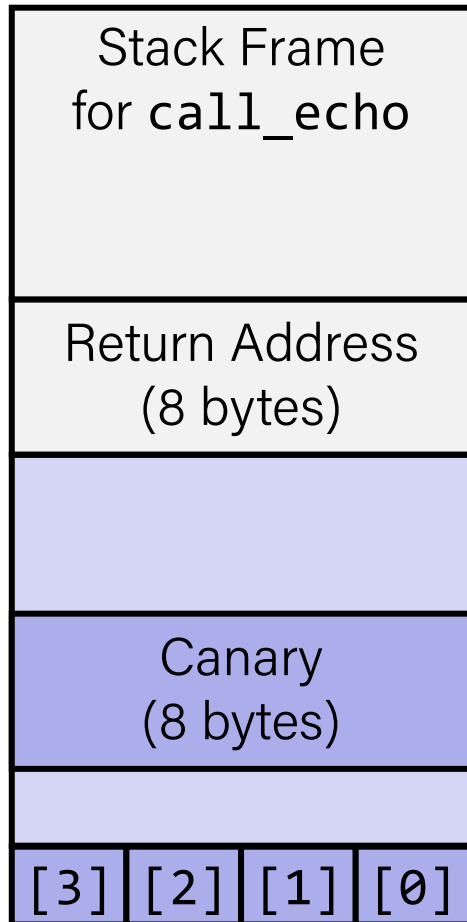

```
/* Echo Line */  
void echo()  
{  
    char buf[4]; /* Way too small! */  
    gets(buf);  
    puts(buf);  
}
```

```
echo:  
    . . .  
    movq    %fs:40, %rax    # Get canary  
    movq    %rax, 8(%rsp)  # Place on stack  
    xorl    %eax, %eax     # Erase canary  
    . . .
```

Checking Canary

After call to gets

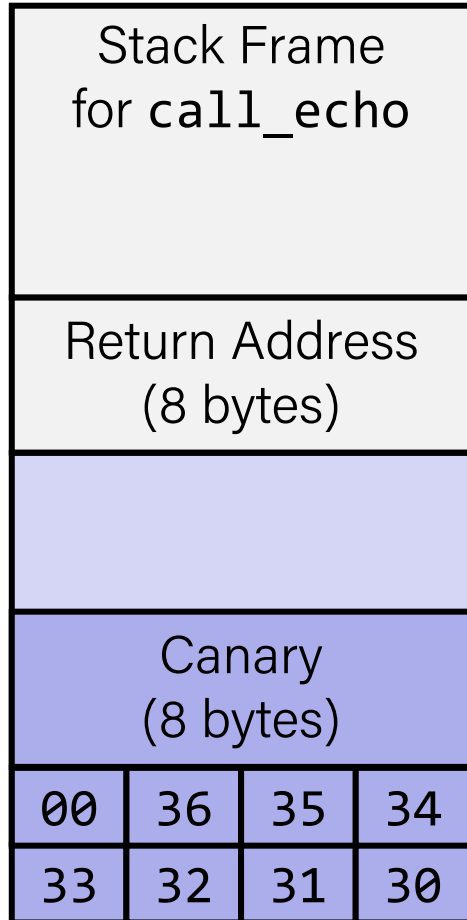

```
/* Echo Line */  
void echo()  
{  
    char buf[4]; /* Way too small! */  
    gets(buf);  
    puts(buf);  
}
```

Input: 0123456

```
echo:  
    . . .  
    movq    8(%rsp), %rax    # Retrieve from stack  
    xorq    %fs:40, %rax    # Compare to canary  
    je     .L6              # If same, OK  
    call   __stack_chk_fail # FAIL  
    .L6:  
    . . .  
buf ← %rsp
```

Return-Oriented Programming Attacks

- Challenge (for hackers)
 - Stack randomization makes it hard to predict buffer location
 - Marking stack nonexecutable makes it hard to insert binary code
- Alternative Strategy
 - Use existing code
 - E.g., library code from `stdlib`
 - String together fragments to achieve overall desired outcome
 - *Does not overcome stack canaries*
- Construct program from gadgets
 - Sequence of instructions ending in `ret`
 - Encoded by single byte `0xc3`
 - Code positions fixed from run to run
 - Code is executable

Gadget Example #1

```
long ab_plus_c  
  (long a, long b, long c) {  
    return a*b + c;  
  }
```

0000000004004d0 <ab_plus_c>:

4004d0: 48 0f af fe imul %rsi,%rdi

4004d4: 48 8d 04 17 lea (%rdi,%rdx,1),%rax

4004d8: c3 retq



$\text{rax} \leftarrow \text{rdi} + \text{rdx}$

Gadget address = 0x4004d4

- Use tail end of existing functions

Gadget Example #2

```
void setval(unsigned *p) {  
    *p = 3347663060u;  
}
```

Encodes `movq %rax, %rdi`

```
<setval>:  
4004d9: c7 07 d4 48 89 c7 movl $0xc78948d4, (%rdi)  
4004df: c3 retq
```

`rdi ← rax`

Gadget address = `0x4004dc`

- Repurpose byte codes

ROP Execution

- Trigger with `ret` instruction
 - Will start executing Gadget 1
- Final `ret` in each gadget will start next one

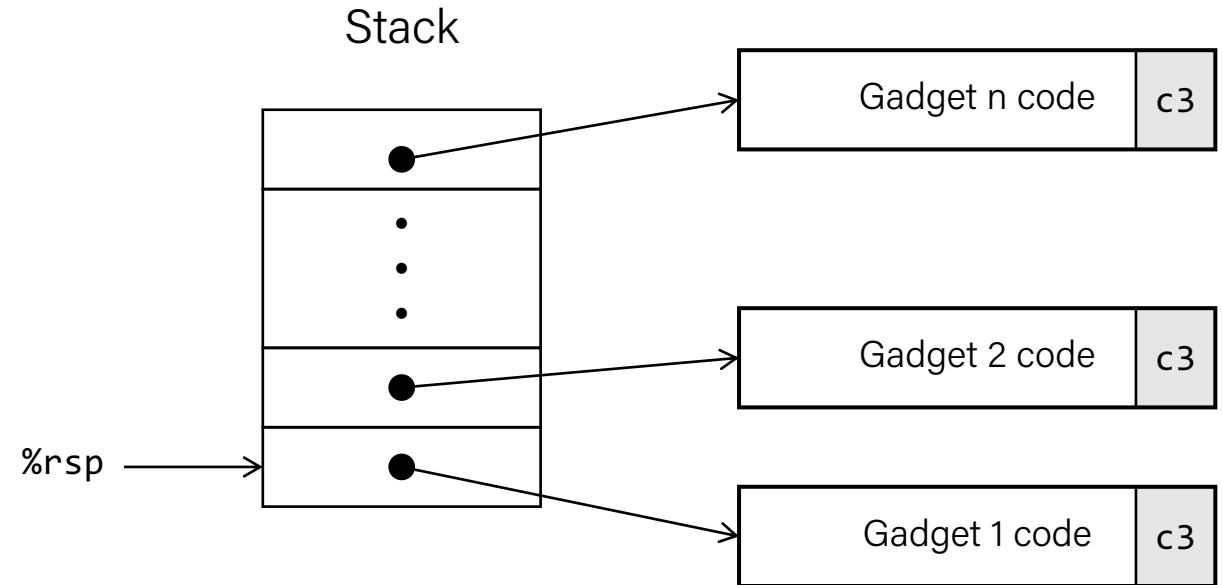

Recap

- Floating Point
- Memory Layout
- Buffer Overflow

Next time: *memory hierarchy*